

# ADDENDUM - All Export 880/850 Hot Tub Models

## 880/850 Export 50Hz Owner's Manual Update, #6530-317 Rev-A

---

The following changes apply to the owners manual identified above:

- Fluidix Intelli-Jet Operation Details (page 1)
  - New Change Filter Reminder Feature (page 2)
  - Revised Hot Tub Gravity Drain Operation Procedure (page 2)
  - Revised 2005+ Cameo Hot Tub “Top View” Figure-F (page 3)
  - Revised Light Button Operation Instructions (page 4)
  - New AquaTerrace Light Controller Operation for 2005 Cameo & Optima (page 4)
  - New AquaTerrace Waterfall Control Valve Operation for 2005+ Cameo & Optima (page 5)
  - Revised Filter Cartridge Replacement Instructions for 2005+ Cameo & Optima (page 6)
- 

### Fluidix Intelli-Jet Operation Details

The Fluidix Intelli-Jets in your new spa offer the advantage of no moving parts and zero maintenance. They can also be adjusted for a high and low impact massage, providing the ultimate massage! Each jet has it's own water volume and directional or oscillating flow adjustment. The jet's outer dial controls water volume (flow rate) and it's center “mode disk” selects either an oscillating or directional flow massage.

### Fluidix Intelli-Jet Adjustment

1. Turn outer dial (A) clockwise to increase water volume. Turn outer dial counterclockwise to decrease water volume or to shut jet off.
2. Rotate center “mode disk” (B) clockwise to select a non-oscillating water stream or turn counterclockwise to select an oscillating stream at any angle.
3. For a high impact massage, turn corresponding air control knob clockwise. For low impact massage, turn corresponding air control knob counterclockwise.

**New Fluidix  
Intelli-Jet**

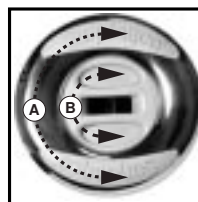

**Air  
Control Knob**



*Note: Always keep at least 6 adjustable jets open at all times on each jet system.*



## Programming The Change Filter Reminder Display

Your new spa may be equipped with a programmable “Change Filter” reminder that appears on the control panel display after a specified number of days. It is designed to remind you to clean and/or replace your filter cartridge(s) on a regular basis but does not affect spa operation in any way. This reminder must be reset at each filter cleaning interval. It offers a selectable range from 10-120 days or can be disabled. We recommend an initial setting of 30 days, after which you can easily determine whether you need to shorten or lengthen its interval by visually inspecting your filter cartridge. Refer to section 11.1 in the supplied owner’s manual for filter cleaning recommendations.



### Programming Instructions

- (1) Press the **CYCLE** sensor three times. The main display reads “FIL” indicating the “Change Filter” display program has been accessed.
- (2) Press **SELECT** sensor once to display currently programmed duration or days elapsed since last filter cleaning interval.
- (3) Press **UP** or **DOWN** sensor to change duration as follows:  
0 - 10 - 20 - 30 - 40 - 50 - 60 - 70 - 80 - 90 - 100 - 110 - 120 - OFF
- (4) Press **DISPLAY** sensor once to save changes and return to the standard water temperature display. *Note: If no sensor is pressed within 30 seconds, the screen will automatically return to the standard water temperature display.*

### Hot Tub Gravity Drain Draining Procedure

1. Turn off power to hot tub at breaker.
2. Locate the 3” gray drain valve cap on the left or right side of the hot tub. Unscrew drain valve cap to expose the underlying male garden hose fitting. Attach hose to fitting and route opposite end away from hot tub.
3. Pull outward on garden hose at drain connection (approx. 3/8”) to open valve and release water. *Water drains at approximately 3 gallons per minute.*
4. Close drain valve by pushing inward on garden hose at drain connection until you feel it bottom out, then remove garden hose, install gray drain cap, and refill spa. *Refer to “Start-Up Instructions” (page 9).*



**Figure-F, Hot Tub Top View**

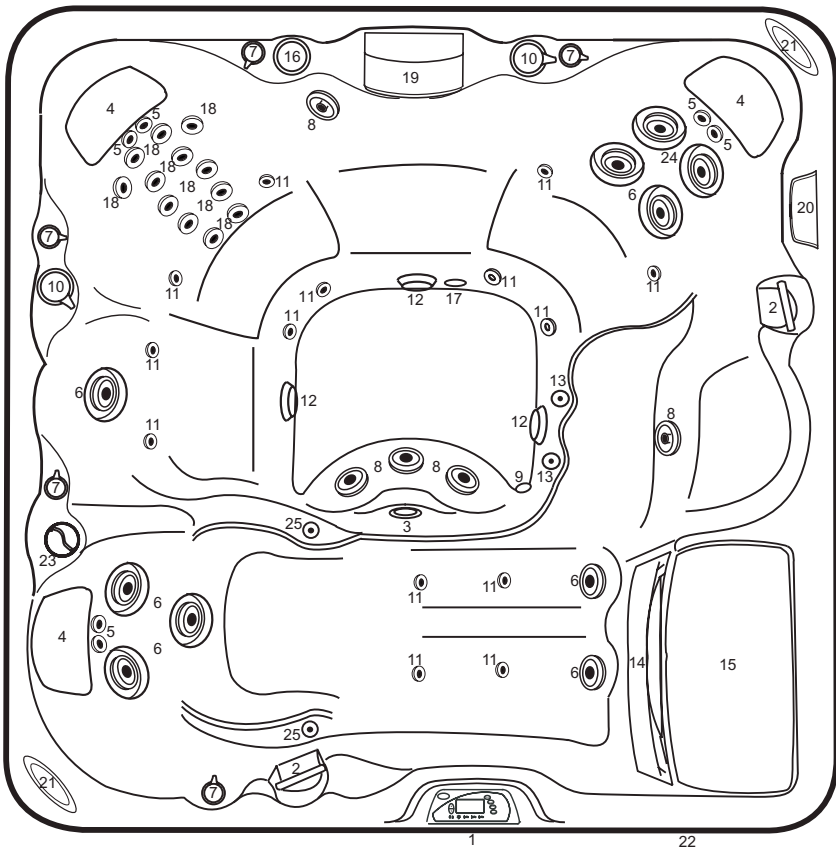

*Note: 2005+ Cameo Model with Optional Audio System Illustrated. 2005+ Cameo/Optima models include the new AquaTerrace waterfall control valve #16, waterfall #19, and light controller #20 as shown. These items are excluded from all other models listed in this manual. These models utilize item #20 as a remote jets controller.*

- |  |   |
|--|---|
| 1. Control Panel   | Require Periodic Cleaning).                 |
| 2. Handrails (2 ea.)   | 13. Accu-Pressure Jets (2 ea.)              |
| 3. Light   | 14. Weir Gate/ Skimmer                      |
| 4. Pillows (3 ea.)   | 15. Filter Lid                              |
| 5. Euro Jets (6 ea.)   | 16. AquaTerrace Waterfall Control Valve     |
| 6. Fluidix Intelli-Jets (8 ea.)  | 17. AquaTerrace Waterfall Filtration Return |
| 7. Air Controls (5 ea.)  | 18. Fluidix ST Jets (12 ea.)                |
| 8. Whirlpool Jets (5 ea.)  | 19. AquaTerrace Waterfall                   |
| 9. Gravity Drain   | 20. AquaTerrace Waterfall Light Control     |
| 10. Massage Selectors (2 ea.)  | 21. Optional Audio System Speakers (2 ea.)  |
| 11. Air Injectors (14 ea.)   | 22. Optional Audio System Receiver          |
| 12. Footwell Suction Covers (3) And Filters<br>(Filters "Socks" on Each Suction Cover<br>Protect Both Diverter Valves From<br>Debris Entrapment/ Damage. Filters | 23. Sunscents Dispenser                     |
|  | 24. Vortex Jets (2 ea.)                     |
|  | 25. Pulsator Jets (2 ea.)                   |

(Location of features varies by model)



## 850 Light Operation (2005+ Marin, Altamar, Capri)

The spa light offers 6 constant color variations and a unique random mode for enhanced spa enjoyment. Press the **LIGHT** sensor pad once to turn the spa light on in “Random” mode, then repeatedly press the sensor pad to turn the light off or to select one of 6 constant colors illustrated below.

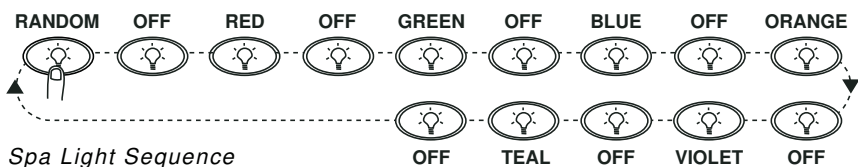

## 880 Light Operation (2005+ Optima & Cameo)

The **LIGHT** button activates the footwell lights when pressed. Note: footwell light color or random mode is selected on the AquaTerrace control panel. See section 9.3 below for details.



## 880 AquaTerrace Light Controller (2005+ Optima & Cameo)

The AquaTerrace light control panel offers a variety of light settings described below. Note: lights automatically turn off after 1 hour use.

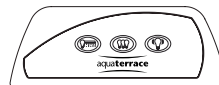

The left button activates, dims, and turns off the waterfall light(s) as shown below.

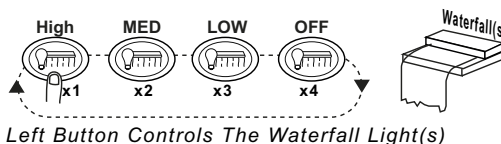

The right button activates, dims, and turns off the footwell light as shown right.

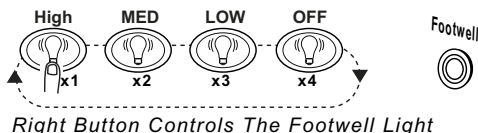

The center button selects random mode, freeze mode, or one of 7 constant colors on the footwell and waterfall lights. In random mode, press a second time to freeze random color or continue pressing for one of 7 constant colors. If you go past your favorite color, simply continue pressing to restart the color selection sequence. Note: your color selection is stored in memory and will automatically recall when the light is cycled on and off.

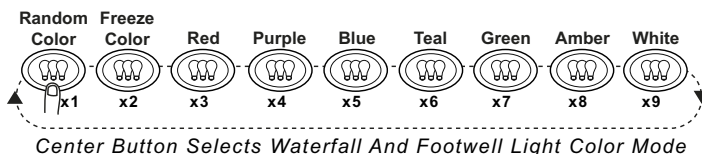



### 880 Waterfall Control Valve (2005+ Optima & Cameo)

Turn valve counterclockwise to increase waterfall output.  
Turn clockwise to decrease or turn off waterfall output.  
Note: it takes 4 full revolutions to change the waterfall from a full off to a full on flow rate.

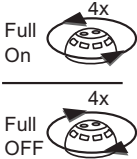

### 880 Filter Cartridge Replacement (2005+ Optima & Cameo)

A programmable "Change Filter" reminder flashes on the control panel display after a specified number days to remind you to inspect and/or replace the MicroClean II filter cartridge. This reminder must be reset at each filter inspection/replace-ment interval. Refer to page 2 of this addendum sheet for additional information and programming details.



Your Sundance hot tub is equipped a high-efficiency MicroClean II filter cartridge under the filter lid. Debris is filtered by the circulation pump drawing water through this cartridge 24-hours a day, 7 days a week (unless pro-grammed otherwise.) To ensure optimum performance, replace this car-tridge every 6 months or as needed. This filter cannot be cleaned and reused and MUST be thrown out after use.

All spas also include filters on their footwell suction covers that prevent debris from entering either jets pump system and related massage selector valve when running. The suction filters must remain in place to protect these components from debris entrap-ment/damage and should be cleaned every 2 months, or when weak jets pump performance is observed.



**ALWAYS TURN POWER TO THE HOT TUB OFF BEFORE REPLACING THE MICROCLEAR II FILTER CARTRIDGE!** To accomplish this, refer to the following filter replacement procedure:

**A**  **TURN POWER TO HOT TUB OFF!** 

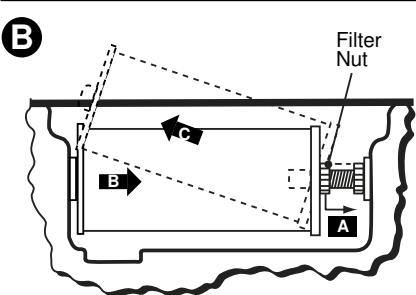

Loosen filter nut (A) to provide clearance, then remove used MicroClean II filter cartridge (steps B-C).

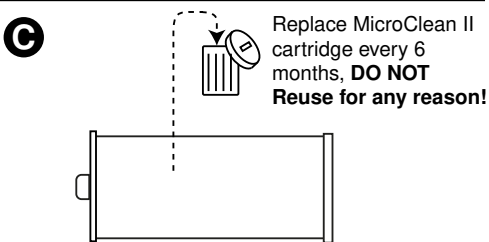

Replace (throw-away) the MicroClean filter cartridge every 6 months, or as needed! **DO NOT reuse this cartridge for any reason!**

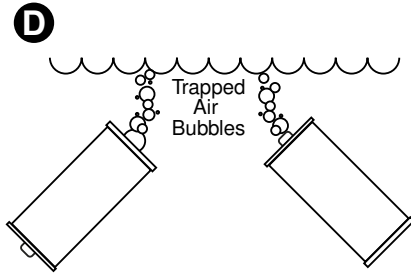

Submerge new filter cartridge in spa and tilt each end upward to remove most of the air bubbles trapped inside the filter.

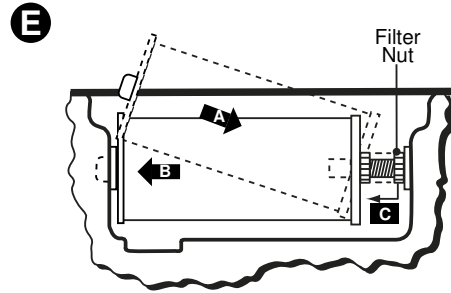

1. Install new filter cartridge, then tighten filter nut until it just touches filter face. **DO NOT OVERTIGHTEN!**
2. Turn power to hot tub back on.

Replacement MicroClean II filter cartridges may be purchased from your Sundance dealer. An optional pleated filter cartridge is also available from your Sundance dealer. This filter can be cleaned and reused for up to two years but does not maintain the same water quality and clarity as the standard MicroClean II cartridge.

NOTE: nylon suction filters are installed on all footwell pump intakes. These filters must be cleaned periodically to ensure optimum jet performance. They are important since they protect your new spa's massage selectors and equipment from debris entrapment damage while either jets pump is running.



# Sundance® Spas



850 Export Series



Séries Exportation 850



850er Serie Export



Installation & Owner's Manual  
Instructions en Français  
Installations- und Bedienungsanleitung

# Table of Contents

<b>1.0</b>	<b>Important Hot Tub Owner Information .....</b>	<b>1</b>
<b>2.0</b>	<b>Important Safety Instructions .....</b>	<b>2</b>
<b>3.0</b>	<b>Locating Your Sundance Hot Tub.....</b>	<b>5</b>
3.1	Outdoor Locations.....	5
3.2	Indoor Locations.....	5
<b>4.0</b>	<b>General Electrical Safety Instructions.....</b>	<b>6</b>
<b>5.0</b>	<b>Electrical Installation Instructions (240V Service) .....</b>	<b>7</b>
<b>6.0</b>	<b>Power Requirements.....</b>	<b>8</b>
<b>7.0</b>	<b>Start-Up Instructions .....</b>	<b>9</b>
<b>8.0</b>	<b>Operating Instructions.....</b>	<b>12</b>
8.1	View.....	12
8.2	Light.....	12
8.3	Air Injection.....	12
8.4	Jets 1 .....	12
8.5	Jets 2 .....	13
8.6	Selecting The Desired Massage Action.....	15
8.7	Adjusting Fluidix Intelli-Jets .....	15
8.8	Air Controls .....	16
8.9	Fragrance Dispenser.....	16
8.10	Optional SunSound™ Audio System .....	16
<b>9.0</b>	<b>Automatic Filtration.....</b>	<b>23</b>
9.1	Preset Skimming/Heating Cycle.....	23
9.2	Standard Skimming/Heating Mode .....	24
9.3	Economy Skimming/Heating Mode.....	24
9.4	Selecting Standard or Economy Skimming/Heating Mode.....	24
9.5	Cleanup Cycle .....	24
<b>10.0</b>	<b>Programming Instructions.....</b>	<b>25</b>
10.1	Adjusting Time of Day.....	25
10.2	Changing The Skimming/Heating Cycle.....	25
10.3	Programming The Change Filter Reminder .....	26
10.4	Programming The Optional Ozonator Cycle .....	26
10.5	Locking The Skimming/Heating Cycle .....	27
10.6	Panel Lock .....	27
10.7	Temperature Setting Lock.....	27





**11.0 Hot Tub Maintenance.....28**  
11.1 Cleaning The Filter.....28  
11.2 Draining and Refilling .....29  
11.3 Cleaning The Hot Tub Interior.....30  
11.4 Pillow Care .....31  
11.5 Maintaining The Wood Cabinet.....31  
11.6 Maintaining The Optional Synthetic Cabinet .....31  
11.7 Maintaining The Cover.....32  
11.8 Winterizing.....32  
11.9 Restarting your Hot Tub in Cold Weather .....33  
11.10 Handrail Maintenance.....33

**12.0 Water Quality Maintenance .....34**  
12.1 pH Control.....34  
12.2 Sanitizing.....34  
12.3 Other Additives.....35  
12.4 Optional SunZone™ Water Maintenance System.....35

**13.0 Troubleshooting - Display Messages.....35**  
**14.0 Troubleshooting - Procedures.....37**  
**15.0 Jumper Configurations/Max Current Chart.....39**  
**16.0 Electrical Wiring Diagram, Export 50Hz.....40**

*Procédure de dépannage standard (Français).....41*  
*Deutscher Abschnitt (Deutsch).....87*

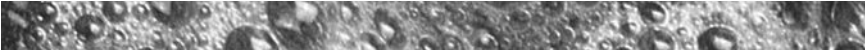

## 1.0 Important Hot Tub Owner Information

Your Sundance hot tub is constructed to the highest standards and is capable of providing many years of trouble-free use. However, because heat retentive materials are utilized to insulate the hot tub for efficient operation, an uncovered hot tub surface directly exposed to sunlight and high temperatures for an extended period is subject to permanent damage. Damage caused by exposing the hot tub to this abuse is not covered by warranty. We recommend that you always keep the hot tub full of water when it is exposed to direct sunlight and that you keep the Sundance insulating cover in place at all times when the hot tub is not in use. Read and carefully follow the requirements for your hot tub's support base found in section 3.0 titled, "Locating Your Sundance Hot Tub" (page 5.)

Sundance Spas constantly strives to offer the finest hot tubs available, therefore modifications and enhancements may be made which affect the specifications, illustrations and/or instructions contained herein.

### FCC Notice

This equipment has been tested and found to comply with the limits for a Class B Digital Device, pursuant to Part 15 of the FCC Rules. These limits are designed to provide reasonable protection against harmful interference in a residential installation. This equipment generates, uses and can radiate radio frequency energy and, if not installed and used in accordance with the instructions, may cause harmful interference to radio communications. However, there is no guarantee that interference will not occur in a particular installation. If this equipment does cause harmful interference to radio or television reception, which can be determined by turning the equipment off and on, the user is encouraged to try to correct the interference by one or more of the following measures: 1) Rearrange or relocate the receiving antenna; 2) Increase the separation between the equipment and receiver; 3) Connect the equipment into an outlet on a circuit different from the circuit connected; 4) Consult the dealer or an experienced radio/TV technician for help. (Changes or modifications not expressly approved by the party responsible for FCC compliance could void the user's authority to operate this equipment.)



## 2.0 Important Safety Instructions

When using this electrical equipment, basic safety precautions should always be followed, including the following:

1. **READ AND FOLLOW ALL INSTRUCTIONS BEFORE OPERATING THE HOT TUB!**
2. **DANGER - RISK OF ELECTRICAL SHOCK:** Install at least 1.5m, from all metal surfaces. A hot tub may be installed within 1.5m of metal surfaces, if in accordance with the country electrical code.
3. **DANGER - RISK OF ELECTRICAL SHOCK:** Do not permit any electrical appliance, such as a light, telephone, radio, television, etc. within 1.5m of a hot tub unless such appliances are built-in by the manufacturer.
4. **CAUTION** - The hot tub must be installed in such a manner as to provide drainage of the electrical equipment compartment.
5. **CAUTION** - This hot tub must be hard-wired to your household electrical service box only. Do not use an extension cord or any other disconnectable power cord. The use of an extension cord or a disconnectable power cord is highly dangerous and will void all manufacturer warranties!
6. A terminal marked G, Gr, Ground, Grounding or with the  symbol is located inside the supply terminal box or compartment (Figure-B, Page 7). To reduce the risk of electric shock, connect this terminal or connector to the grounding terminal of your electrical service or supply panel with a continuous green insulated copper wire equivalent in size to the circuit conductors supplying this equipment, but no smaller than 10mm<sup>2</sup>. In addition, a second wire connector is provided for bonding to local ground points. To reduce the risk of electrical shock, this connector should be bonded with a 10mm<sup>2</sup> copper wire to any metal ladders, water pipes, or other metal objects within 1.5m of the hot tub.
7. The electrical supply for this product must include a suitably rated switch or circuit breaker to open all ungrounded supply conductors to comply with country electrical code.

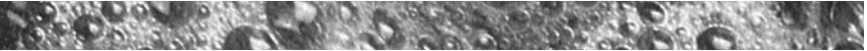

8. Overflowing or Overfilling: Overfilling can cause the hot tub to siphon out water through the air venturis. Overfilling problems are not covered by the warranty.
9. Before entering a hot tub, the user should measure the water temperature with an accurate thermometer since the tolerance of the water temperature-regulating device may vary as much as  $\pm 3^{\circ}\text{C}$ .
10. Always enter and exit the hot tub slowly and cautiously. Wet surfaces will be slippery.
11. Do not use the hot tub while alone.
12. **WARNING - RISK OF CHILD DROWNING:** Extreme caution must be exercised to prevent unauthorized access by children. To avoid accidents, ensure that children cannot use the hot tub unless they are supervised by an adult at all times.
13. **DANGER** - To reduce the risk of injury, do not remove any drain suction gate or cover.
14. Never use the weir gate for sitting or for resting your feet. It is designed to float freely.
15. The water in the hot tub should never exceed  $40^{\circ}\text{C}$ . Water temperatures between  $38^{\circ}\text{C}$  and  $40^{\circ}\text{C}$  are considered safe for a healthy adult. Lower water temperatures are recommended for extended use (exceeding 10 - 15 minutes) and for young children.
16. Since excessive water temperatures have potential for causing fetal damage during the early months of pregnancy, pregnant or possibly pregnant women should limit hot tub or spa water temperatures to a maximum of  $38^{\circ}\text{C}$ .
17. The use of alcohol, drugs, or medication before or during hot tub use may lead to unconsciousness with the possibility of drowning.
18. Persons suffering from obesity or with with a medical history of heart disease, low or high blood pressure, circulatory system problems, or diabetes should consult a physician before using a hot tub.



19. Persons using medication should consult a physician before using a hot tub since some medications may induce drowsiness while other medications may affect heart rate, blood pressure, and circulation.
20. Long exposures in the hot tub may result in nausea, dizziness or fainting. Observe a reasonable time limit, leave the hot tub, then shower, cool down, and if you wish, return for another brief stay.
21. Excessive temperatures may cause hyperthermia. The symptoms and first aid information are as follows:
  - A. Heat Stroke: The most susceptible people are the very young and elderly, alcoholics and most people under the influence of drugs, medication and alcohol.
  - B. Symptoms: Hyperthermia causes loss of salt, sweating, dizziness, headache, dryness of mouth and nausea, faintness and/or unconsciousness, convulsions, flushed appearance of skin, and rapid pulse and/or weak, shallow breathing.
  - C. Treatment: Place the victim on his back, head slightly elevated. Apply wet cloths or ice packs to the head, wrap the body in a sheet, pouring on a small amount of water. Follow with a cool shower or bath. Get medical attention as soon as possible.
22. It is recommended that the following emergency telephone numbers be listed at the nearest telephone: physician, hospital, ambulance, and police.

### **23. SAVE THESE INSTRUCTIONS!**



### 3.0 Locating Your Sundance Hot Tub

**IMPORTANT:** Because of the combined weight of the hot tub, water and users, it is extremely important that the base upon which the hot tub rests be smooth, flat, level and capable of uniformly supporting this weight, without shifting or settling, for the entire time the hot tub is in place. If the hot tub is placed on a surface which does not meet these requirements, damage to the skirt and/or the hot tub shell may result. Damage caused by improper support is not covered under the factory warranty. It is the responsibility of the hot tub owner to assure the integrity of the support at all times.

We recommend a poured, reinforced concrete slab with a minimum thickness of 10cm. Wood decking is also acceptable provided it is constructed so that it meets the requirements outlined above.

The hot tub must be installed in such a manner as to provide drainage away from it. Placing the hot tub in a depression without provisions for proper drainage could allow rain, overflow and other casual water to flood the equipment and create a wet condition in which it would sit. For hot tubs which will be recessed into a floor or deck, install so as to permit access to the equipment, either from above or below, for servicing. Make certain that there are no obstructions which would prevent removal of the cabinet side panels, especially on the side with the equipment bay doors.

#### 3.1 Outdoor Locations

In selecting the ideal *outdoor* location for your hot tub, we suggest that you take into consideration 1) the proximity to changing area and shelter (especially in colder weather); 2) the pathway to and from your hot tub (this should be free of debris so that dirt and leaves are not easily tracked into the hot tub); 3) the closeness to trees and shrubbery (remember that leaves and birds could create extra work in keeping the hot tub clean); 4) a sheltered environment (less wind and weather exposure can result in lowered operation and maintenance costs); and 5) the overall enhancement of your environment. It is preferable *not* to place the hot tub under an unguttered roof overhang since run-off water will shorten the life expectancy of the hot tub cover.

#### 3.2 Indoor Locations

For *indoor* installations, be certain to make provisions for proper ventilation. When the hot tub is in use, considerable amounts of moisture will escape. This can damage certain surfaces over time.



If you have any questions regarding the placement or installation of your hot tub, consult your authorized Sundance Dealer.

## 4.0 General Electrical Safety Instructions

Your new Sundance hot tub is equipped with the "state-of-the-art" Sentry™ equipment system. It contains the most advanced safety and self-protective equipment in the industry. Nonetheless, this hot tub must be installed properly to insure dependable usage. Please contact your local government authority should you have any questions regarding your installation. In the event they are unable to answer your questions, direct your inquiries to Sundance Spas. Please refer to the rear cover of this manual for our address and telephone number.

Proper grounding is extremely important. Sundance hot tubs are equipped with a current collector system. A pressure wire connector located on the surface of the control box, located inside the equipment door (Figure B, page 7) to permit connection of a bonding wire between this point and any ground metal equipment, metal water pipe or conduit within 1.5m of the hot tub, or copper clad grounding rod buried within 1.5m of the hot tub. Bonding wire must be at least 10mm<sup>2</sup> solid copper wire. This is a most important safety assurance feature.

**Figure-A, Equipment Area**

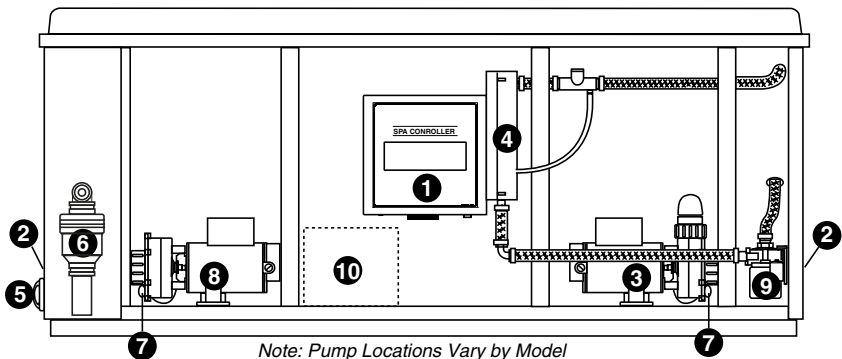

- |                                  |                                       |
|----------------------------------|---------------------------------------|
| 1. Sentry Control Box            | 7. Pump Drain Plug(s)                 |
| 2. Power Supply Cabinet Inlet(s) | 8. Pump #2 (N/A Capri)                |
| 3. Pump #1                       | 9. Circulation Pump                   |
| 4. Heater                        | 10. Optional Audio System Subwoofer - |
| 5. Hot Tub Drain                 | Behind Bulkhead (Models with          |
| 6. Air Blower                    | Audio Option Only)                    |

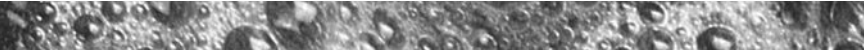

Before installing this hot tub, check with the local government/electrical authority to insure installation conforms to local country/area states codes.

### 5.0 Electrical Installation Instructions (240V Service)

**IMPORTANT NOTICE:** The electrical wiring of this hot tub must be installed by a qualified electrician to comply with all regulations and standards specified by the electrical authority in your state or country.

Figure-B, Sentry Control Box

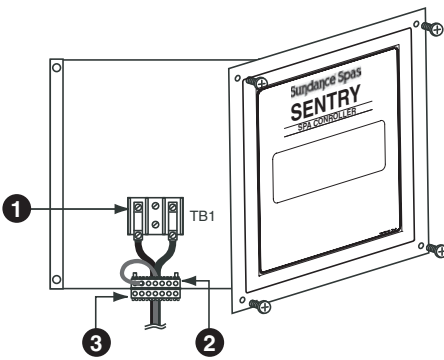

- 1. Terminal Block
- 2. Bonding Lug
- 3. Grounding Terminal

Figure-C, Terminal Block TB1 230V Wire Connection

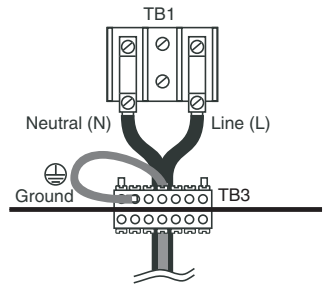

1. This hot tub must be permanently connected (hard-wired) to the power supply. **No plug-in connections or extension cords are to be used in conjunction with the operation of this hot tub.** Supplying power to the hot tub which is not in accordance with these instructions will void both the independent testing agency listing and the manufacturer’s warranty.
2. The power supplied to this hot tub *must* be a *dedicated* circuit with no other appliances or lights sharing the power provided by the circuit.
3. To gain access to the hot tub’s power terminal block, remove the screws securing the center wood cabinet panel on the side of the hot tub under the controls. Then remove the four metal control box door screws and door (Figure B).





4. Select the power supply cabinet inlet you want to use (Figure-A, Page 6), Install the power cable through the large opening provided in the bottom of the metal control box.
5. Hot tubs with one main terminal block (Figure-B, Page 7) must be supplied with 20 Amps. *Note: the 850 series hot tub can be adapted to use higher amperage circuits when available. Contact your Sundance dealer for details.*
6. The electrical supply for this product must include a suitably rated isolating switch and circuit breaker to comply with local electrical regulations. This RCD/GFCI circuit breaker must be installed at the power supply in the house electrical box.
7. Connect wires to power terminal blocks TB1 and TB3 as illustrated (Figure C, Page 7). **TIGHTEN SECURELY!** All wires must be hooked up securely or damage could result.
8. Install metal control box door and screws. Then reinstall the center wood cabinet panel and screws.

## **6.0 Power Requirements**

Sundance hot tubs are designed to provide optimum performance and flexibility of use when connected to the maximum electrical service as listed below. If you prefer, your Sundance dealer can perform a minor circuit board modification to allow an alternate electrical service. The operational considerations of these modifications are listed in the footnotes.

### **CAMEO, OPTIMA, MARIN and ALTAMAR Models**

Voltage	230 VAC	230 VAC
Frequency	50Hz	50Hz
Max. Current Draw	16.6 Amps*	31.6 Amps**
Wattage:	3.8kW	7.3kW
Number of Wires	Three	Three

\* Standard 16.6 Amp (3.8kW) configuration: the heater **will not operate** while both jets pumps are running.

\*\* Alternate 31.6 Amp (7.3kW) configuration: the heater **will operate** while both jet pumps are running.



**CAPRI Models**

Voltage	230 VAC	230 VAC
Frequency	50Hz	50Hz
Max. Current Draw	12.1 Amps*	23.6 Amps**
Wattage:	2.8kW	5.4kW
Number of Wires	Three	Three

- \* Standard 12.1 Amp (2.8kW) configuration: the heater **will not operate** while the jets pumps is running.
- \*\* Alternate 23.6 Amp (5.4kW) configuration: the heater **will operate** while the jets pumps is running.

Listed above are the most common power configurations by model. Current/wattage requirements for each model change depending on device\* availability. Basically, the more functions (electrical devices) in a spa, the greater its current/wattage demand. Refer to the jumper configuration/max current chart (page 39) for a complete listing of power requirements for each device within your spa.

*\*Device = Heater, Pump(s), Blower*

## **7.0 Start-Up Instructions**

**FOR BEST RESULTS, READ EACH STEP IN ITS ENTIRETY BEFORE PROCEEDING WITH THAT STEP.**

### **A. Prepare Hot Tub for Filling**

- Clear all debris from the hot tub. (Although the hot tub shell has been polished at the factory, you may want to treat it with a specially formulated hot tub cleaner and wax available from your dealer prior to filling the first time.)
- Remove the filter lid (Figure-F, Page 14), then remove filter cartridge as illustrated in section 11.1, page 28-29.

### **B. Fill Hot Tub**

- Place the end of your garden hose into the empty filter bucket.

**NOTE:** Never fill with water from a water softener. If your water is extremely "hard", it is preferable to fill half-way with hard water and the rest of the way with softened water. Or, you may fill entirely with hard water if you use a special water additive available from your Sundance dealer.



- Fill the hot tub until the water level is midway in the filter bucket skimmer opening and above all jets. **Do not overfill.**

**Important:** Always fill your hot tub through the filter bucket after draining. Failure to do so may cause air to be trapped in either pump, preventing the pump from circulating water.

- Remove hose and replace filter cartridge as illustrated in section 11.1, page 28-29 (Figure-G).

### C. Turn On Power

Turn on power to hot tub at the home's circuit breaker. The heater and circulation pump will automatically activate. If the control panel LCD flashes water temperature and "COOL" or "ICE", pump 1 will also activate. If this occurs, refer to page 35-36 for additional information.

### D. Activate Jets and Blower

Depress the **JETS 1** and **BLOWER** sensor pads on the control panel once to activate pump #1 and blower, initiating water flow.



### E. Add Start-Up Chemicals

Add the hot tub water chemicals as recommended by your Sundance Dealer. (See section titled WATER QUALITY MAINTENANCE (page 34) for general guidance.) *Note: make sure equipment is running before adding chemicals of any type (see step D).*

### F. Set Hot Tub to Heat

The hot tub can heat in either **STANDARD** or **ECONOMY** mode. The tub's built-in temperature sensor will activate the heater automatically when necessary to maintain the water temperature within a range of  $\pm 1^{\circ}\text{C}$  of the set temperature. The time required for initial heat-up will vary depending on the temperature of the water used to fill the hot tub, the size of your hot tub, and the ambient temperature. The water temperature will rise approximately 2 to 3  $^{\circ}\text{C}$  per hour in larger tubs, and approximately 4 to 5  $^{\circ}\text{C}$  per hour in smaller tubs.

### G. Choosing "Standard" or "Economy" Mode

Press the **MODE** button to select either "Standard" or "Economy" operating modes. The control panel's right-side LCD display indicator changes to indicate which mode is selected. By selecting the appropriate operating mode, you can ensure that the spa will be ready to use when you want it with the lowest possible energy consumption.



When power is turned on, the spa defaults to STANDARD mode. In STANDARD mode, the skimming/heating cycle will activate pump 1 as programmed to provide skimming action and additional filtration. In ECONOMY mode, the skimming/heating cycle will not come on. This is the main difference between the two operating modes.

**WARNING - RISK OR INJURY**

Always check the water temperature carefully before entering the hot tub.

**H. Setting Desired Temperature**

To warm hot tub water to a comfortable temperature, follow these steps:

- The LCD display on the control panel displays the actual temperature of the hot tub water. Press either the **COOLER** (Down) or **WARMER** (Up) sensor pad once to display the “set temperature” for 5 seconds. If you want the water to heat to a different temperature, simply press **COOLER** (Down) or **WARMER** (Up) within 5 seconds. The set temperature advances or decreases by one degree each time one of these sensor pads is pressed.
- The heater will turn off when the temperature corresponding to the thermostat setting is achieved.

***Important Heater Details:***

- *The maximum temperature for which the hot tub can be set is 40 °C and the minimum is 26 °C.*
- *Setting the thermostat at maximum will not accelerate the heating process. This will only result in a higher ultimate temperature.*
- *The heater operates until the water reaches the programmed “set temperature”, then turns off. The heater will reactivate after the water cools to approximately 1 °C below the “set temperature.”*

**I. Place Cover On Hot Tub**

- Keeping the insulating cover in place anytime the hot tub is not in use will reduce the time required for heating, thereby minimizing operating costs.
- The time required for initial heat-up will vary depending on the starting water temperature and the capacity of your hot tub. Larger hot tubs heat at about 2 to 3 °C per hour; smaller hot tubs heat at a rate of approximately 4 to 5 °C per hour.



## 8.0 Operating Instructions

Your Sundance hot tub has a touch-sensitive control panel, massage selector valves and air control knobs located on the top rim of the hot tub (Figure-F, page 14). These controls let you operate many of the special functions of your Sundance hot tub. By familiarizing yourself with the following information, you will be able to gain the full benefit afforded by the various functions of your hot tub.

### 8.1 View

Pressing this sensor pad inverts the main four-digit display on the Command Center's LCD screen to allow easy reading from either inside or outside the hot tub.



### 8.2 Light

The **LIGHT** sensor pad activates both the underwater light and the light symbol on the LCD screen when pressed. To reduce the brightness of the light, press the sensor pad again. A third press will result in an even lower level of illumination. A fourth press turns the light off. If left on, the light will automatically turn off after one hour.



There are two colored lenses included with your hot tub which may be placed over the light lens inside the hot tub. To remove a lens, pull straight out. To install a lens, align tabs and push straight in. Your hot tub comes with a clear lens installed.

The optional SunGlow™ Multi-Colored LED Light Kit (#6560-240) can retrofit the factory installed spa light. This option offers 7 light colors and a unique random mode for enhanced spa enjoyment. Consult your Sundance Dealer for additional information.

### 8.3 Air Injection

When the **AIR** sensor pad is pressed, the air blower forces air through the injectors located in the seats and footwell. The bubbles symbol above the sensor pad appears on the LCD display whenever the air blower is on. *An electronic timer automatically turns the air blower off 20 minutes after it was turned on. Note: The air blower automatically activates for 1 minute at the start of the clean-up cycle at 12:00 (Noon). This clears the lines of the air injector system to help ensure that all water is exposed to sanitizer. This cycle is non-programmable.*



**8.4 Jets 1** - The sensor pad labeled **JETS 1** controls the main jets pump #1. Pressing this sensor turns pump #1 on and off.



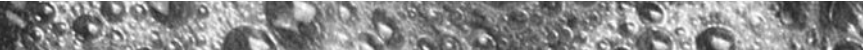

### 8.5 Jets 2 - On models with two jet pumps, **JETS 2** controls the high-speed pump #2.



**Auto Turn Off** – Anytime a pump has been manually turned on, it will automatically turn off after approximately 20 minutes. If at this time you desire more jet operation you may simply turn the pump(s) back on.

#### Figure-D, Command Center

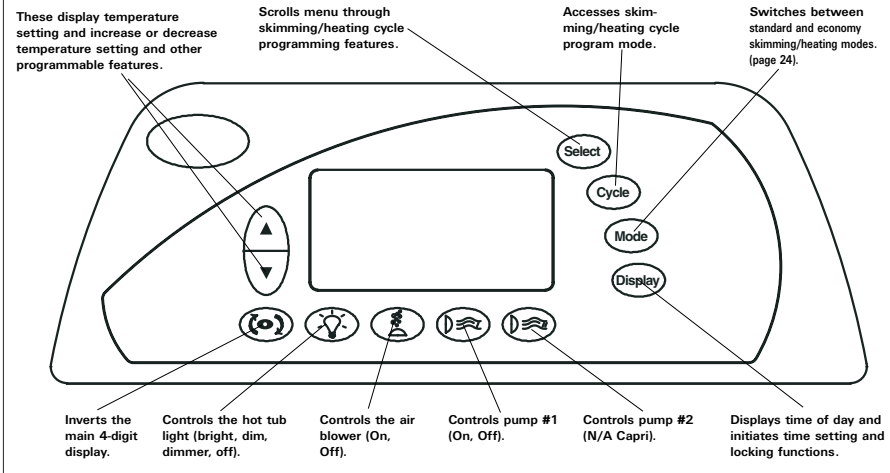

#### Figure-E, LCD Display

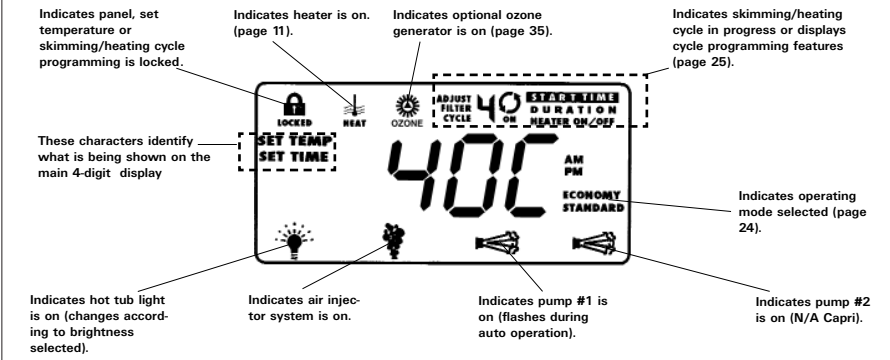
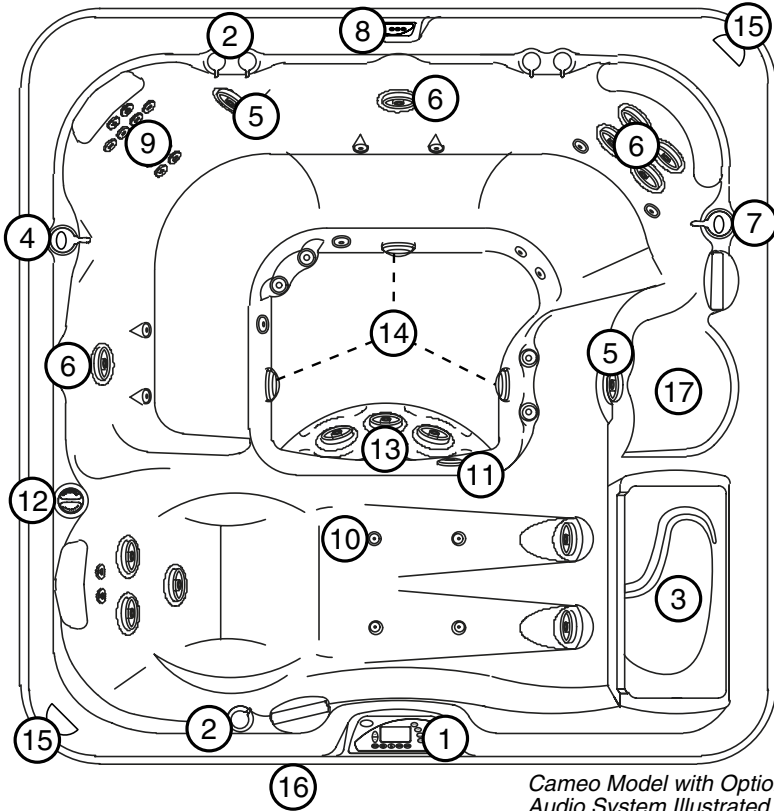



Figure-F, Hot Tub Top View



*Cameo Model with Optional Audio System Illustrated*

- |  |  |
|--|--|
| 1. Control Panel                         | 12. Fragrance Dispenser  |
| 2. Air Controls                          | 13. Vertical Jets  |
| 3. Filter Lid                            | 14. Footwell Suction Fittings and Filters (Filters protect diverter valve from debris entrapment/damage. Filters require periodic cleaning). |
| 4. Massage Selector Valve #1             | 15. Optional Audio System Speakers (2 places)  |
| 5. Whirlpool Jets (N/A Capri)            | 16. Optional Audio System Receiver   |
| 6. Therapy Jets (Fluidix Intelli-Jets)   | 17. Cool Down Seat.  |
| 7. Massage Selector Valve #2 (N/A Capri) |  |
| 8. Auxiliary Control Panel (N/A Capri)   |  |
| 9. Therapy Seat                          |  |
| 10. Air Injectors                        |  |
| 11. Hot Tub Light                        |  |

(Location of features varies by model)

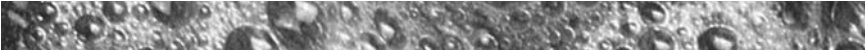

### 8.6 Selecting The Desired Massage Action

Your Sundance spa is equipped to allow you to customize the massage action you desire. Each model incorporates a diverter valve(s) that allow you to customize the massage and performance by diverting water between various jet systems. Simply turn diverter to position A (Combo), B, or C to divert water pressure to various jet groups. *Note: The diverter valve is designed to operate in positions A (Combo), B, and C for optimum performance. It is considered normal for sound levels within the valve to vary between positions due to the large amounts of water flowing through it! For optimum filtration benefits, leave the valve in position A when spa is covered. Select position B or C for maximum jet performance during spa use.*



In the Optima, Cameo and Marin, one massage selector controls the therapy jets and whirlpool jets. The other massage selector controls the therapy seat jets and vertical jets (foot jets).

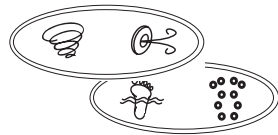

In the Altamar, the massage selector on the pump #2 system diverts between the therapy seat and the whirlpool jets (in the footwell and on the side wall). The pump #1 system powers the therapy jets in the lounge and seats of the hot tub.



### 8.7 Adjusting Fluidix Intelli-Jets

The Fluidix Intelli-Jets in your new spa offer the advantage of no moving parts and zero maintenance. They can also be adjusted for a high and low impact massage, providing the ultimate massage! Each jet has it's own water volume and directional or oscillating flow adjustment. The jet's outer dial controls water volume (flow rate) and it's center "mode disk" selects either an oscillating or directional flow massage.

#### To Adjust Jets

1. Turn outer dial (A) clockwise to increase water volume. Turn outer dial counterclockwise to decrease water volume or to shut jet off.
2. Rotate center "mode disk" (B) clockwise to select a non-oscillating water stream or turn counterclockwise to select an oscillating stream at any angle.
3. For a high impact massage, turn corresponding air control knob clockwise. For low impact massage, turn corresponding air control knob counterclockwise.



*Note: Always keep at least 6 adjustable jets open at all times on each jet system.*





## 8.8 Air Controls

Each jet system has its own air control. These controls allow you to regulate the amount of air which is mixed with the water entering through the jets. Clockwise rotation adds more air and counterclockwise rotation reduces air flow. *To minimize heat loss, these controls should be closed when the hot tub is not in use.*



## 8.9 Fragrance Dispenser

On the rim of your hot tub is a screw-off cap labeled “SunScents Fragrance Dispenser” (Figure-F, Page 14). It is designed to contain packages of a specially made fragrance available from your Sundance dealer. The fragrance is carried into the hot tub water by the air coming through the injector system when the air blower is on.



**WARNING** To prevent personal injury, always turn off air blower before removing or installing SunScents dispenser cap.



**CAUTION:** Use Only Sundance SunScents™ Fragrances in your new hot tub. Never remove the SunScents™ beads from their plastic cage for any reason. Install bead cage directly into SunScents™ dispenser. Never use this dispenser for any other type of fragrance. Always make certain that the dispenser cap is securely in place before operating the hot tub's air blower.

## 8.10 Optional SunSound™ Audio System

Sundance models with the optional audio system offer enhanced spa enjoyment by offering an integrated state-of-the-art audio system. These models include a high-quality AM/FM/CD splash-resistant marine stereo receiver, two high-quality marine speakers, and an integrated subwoofer for long-life and an excellent sound quality. Two speakers located on spa corners (Figure-F, page 14) are designed for manual exposure and retraction. To expose each speaker for audio playback, simply press down on each enclosure to unlatch its “pop-up” mechanism, then release. To retract each speaker before covering spa, gently press downward on each enclosure until you feel a slight “click”, then release.

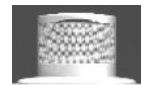

**CAUTION:** Never step or sit on a speaker enclosure! This type of misuse will damage the speaker enclosure latching and track mechanism. Always retract speakers prior to covering spa.



### Optional SunSound™ Stereo Receiver Features

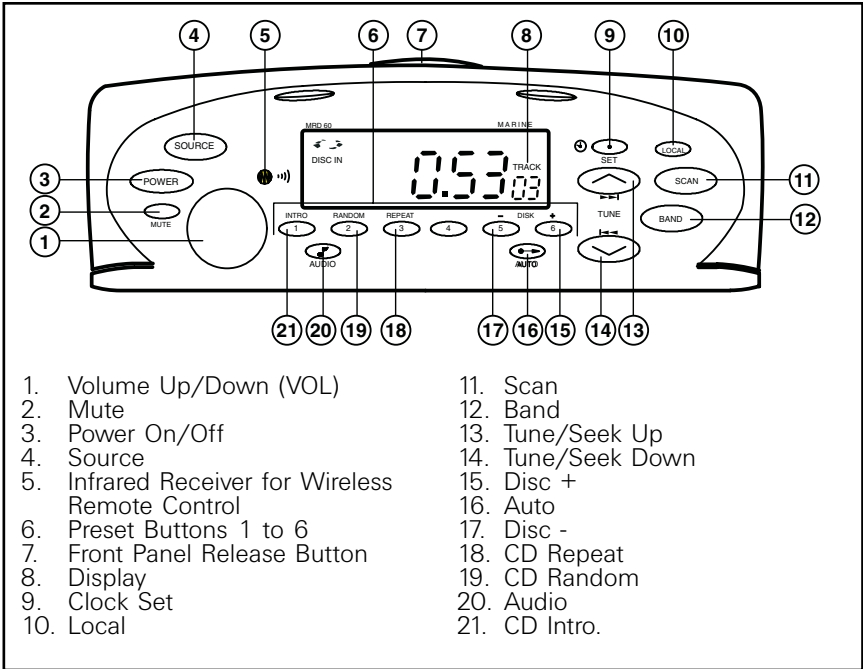

### Optional SunSound™ Stereo Receiver General Controls

#### A. Power On and Off

Make spa power is turned on, then press power button (3) once to turn on. Press a second time to turn off.

#### B. Adjusting Volume

Rotate volume knob (1) to increase or decrease volume. Current volume setting is briefly indicated on the display (0 to 31).

#### C. Mute

Press mute button (2) once to mute audio output ("Mute" flashes on display). To restore audio output, press mute button a second time, or rotate volume knob.

#### D. Program Selection

Press source button (4) to cycle through available program sources as follows: Tuner - CD - Tuner. If a source is unavailable (e.g. no CD inserted), that source will not appear on the display.

**E. Adjusting Bass Level**

Press audio button (20) until display reads "BAS." Rotate volume knob to desired setting. A display of "C 0" indicates center, -2 to -12 indicates bass cut, and +2 to +12 indicates bass boost. *Note: unit returns to volume mode if volume control is not rotated for 3 seconds.*

**F. Adjusting Treble Level**

Press audio button (20) until display reads "TRE." Rotate volume knob to desired setting. A display of "C 0" indicates center, -2 to -12 indicates treble cut, +2 to +12 indicates treble boost. *Note: unit returns to volume mode if volume control is not rotated for 3 seconds.*

**G. Adjusting Balance**

Press the audio button (20) until display indicates "BAL." Rotate volume knob to desired setting. A display of "C 0" indicates center, L1 to 15 indicates left balance, R1 to 15 indicates right balance. *Note: unit returns to volume mode if volume control is not rotated for 3 seconds.*

**Optional SunSound™ Stereo Receiver Radio Operation****A. Adjust Fader**

Press audio button (20) until display reads "FAD." Rotate volume knob to desired setting. A display of "C 0" indicates center, "R" 1 to 15 indicates rear fade, "F" 1 to 15 indicates front fade. *Note: unit returns to volume mode if volume control is not rotated for 3 seconds.*

**B. Display Clock**

Press set button (9) to toggle display between clock and radio modes. When clock mode is selected, the current time displays whenever the unit is left undisturbed.

**C. Set Clock**

Press and hold set button (9) for 2 seconds until first time digit flashes on display. Use tune/seek-up button (13) or tune/seen-down button (14) to set hour, noting AM/PM indicator at left. Briefly press set button a second time to select minutes display. Press set button a third time to complete procedure. Unit remains in clock mode and displays time after 3 seconds. *Note: When power to spa is shut off for any reason, the clock will be reset to 12:00 AM.*



#### D. Open/Close Front Panel

Place thumb on front panel release button (7) with forefinger below front overhang. Press firmly on release button, then flip panel open by pulling outward at top edge. To close panel, flip panel up and press firmly until you hear an audible click. Keep the front panel closed at all times to prevent water intrusion, except when changing discs. **CAUTION: never insert wet discs into unit or CD player will be damaged!**

#### E. Radio Operation

Press source button (4) to select radio mode. Station frequency is indicated on display.

- To Select Band: press band button (12) to toggle through radio modes as follows: FM1 - FM2 - FM3 - AM1 - AM2 - FM1. Each radio band stores up to 6 independent presets, for a total of 18 FM and 12 AM presets.
- To Program Presets: tune in desired radio station, then press and hold desired preset button for at least 2 seconds. "PX", where X=preset number, appears at bottom right of the display. *Note: When power to spa is shut off for any reason, all station presets are reset.*

#### F. Automatically Setting Station Presets

To automatically set station presets to their next higher stations, press the preset button (1 to 6) from which to start programming, then press and hold the auto button (16) for at least 2 seconds. The current station preset and additional preset memories up to P6 will be reprogrammed with their next higher tunable stations. When the auto preset cycle is complete, the unit will remain in preset scan mode and continue scanning for presets until the auto button (16) is pressed. To select only the strongest stations, press the local button (10). All 18 FM and 12 AM presets can be set sequentially by selecting the next band and continuing the operation during auto programming.

#### G. Seek / Manual Tune

Press tune/seek-up button (13) once to automatically tune the next higher station. Press tune/seek-down button (14) once to automatically tune the next lower station. To manually tune to a specific station frequency, press and hold either tune/seek button for at least 2 seconds. Holding either button down will increase or decrease the displayed frequency manually. When the desired frequency is reached, release the button. The unit remains in manual tune mode for 3 seconds after either button is released so you can fine tune the station frequency with additional button presses. *Note: After 3 seconds, seek mode is re-enabled.*



## H. Scan Functions

Select any AM or FM band and press scan button (11) to listen to a few seconds of each radio station. The display will flash and the radio will automatically scan to the next higher station, play that station for a few seconds, then scan to the next higher station. To stop scanning and continue listening to the current station, press scan button a second time.

*Note: the radio remains in scan mode until the scan button is pressed a second time or one of the tune buttons is pressed.*

## I. Preset Scan Function

Press the auto button (16) once to enter scan mode. The next higher preset station will be selected and be played for 3 seconds while the preset number on the display flashes. If you wish to remain on this station, press the auto button (16) a second time. *Note: preset scanning continues unless you press the auto button (16) or either preset button (P1-P6) to cancel.*

## J. Local/Distance Function

Press the local button (10) to toggle between local and distant station mode. When "LOCAL" is displayed, only the strongest stations will be selected during seek or scan. *Note: in the default mode (no LOCAL display), all usable stations will be selected during seek or scan.*

## K. Changing Tuner Frequency from Europe to US

Your unit is factory set to Europe tuning frequency steps. To switch to US tuning steps, use the switch on the bottom of the unit. With the unit disconnected from the power source, use a screwdriver to *slide the switch to the desired position.* ***Note: power must be removed from the radio, or the reset switch must be pressed before the new frequency mode is activated.***

## Optional SunSound™ Stereo Receiver CD Player Operation

### A. Insert, Play, and Eject a CD

Open the front panel and insert a CD into the slot with the CD label facing up. The CD will be drawn inside by the motorized mechanism. Close the front panel. The "DISC IN" symbol on the display indicates that a CD is in the drive.

- To play CD: press the source button (4) to change to CD mode. The CD will play. The display shows the current track and play time, and will animate a 3-D rotating disc while the CD is playing. *Note: if CD*



*play time is not shown, press clock set button (9) once.*

- To remove CD: open the front panel and press the CD eject button located under the front panel. Remove CD from drive and close front panel. **CAUTION: listen for an audible click to ensure the front panel is closed to prevent water intrusion that could damage your unit.**

## **B. Changing CD Tracks and Music Seek**

To advance to the next track, press the tune/seek-up button (13) once and the track counter will increase one track. When the final track is reached on the CD, play will resume on track #1.

- To fast forward through tracks: press and hold the tune/seek-up button (13) until the track counter displays the desired track, then release the button.
- To return to the beginning of the current track: press the tune/seek-down button (14). Pressing it a second time within 1 second will skip back to the previous track.
- To rewind the current track: press and hold the tune/seek-down button (14). The track will quickly rewind until you release the button.

## **C. Intro Scan, Random, Repeat**

- Intro Scan Mode: press intro button (21) to enter intro scan mode. The left side of the display reads "SCN" and the first 10 seconds of each CD track will play continuously until you press the intro button a second time, or press either tune/seek-up button (13) or tune/seek-down button (14).
- Random Mode: press the random button (19) to play the CD tracks in random order. The left side of the display reads "RDM" when random mode is enabled.
- Repeat Mode: press the repeat button (18) to repeat the current CD track continuously. The left side of the display reads "RPT" when repeat mode is enabled.

## **Optional SunSound™ Stereo Receiver Troubleshooting**

### **A. Unit will not turn-on**

Make sure spa power is turned on, then check both harness fuses on back of unit making sure they are the proper ratings:

- Yellow memory B+ line (1A fuse); Red ACC line (10A fuse).
- With spa power off, use a thin rod to press the reset button located under the front panel.



**B. Fogged CDs and Lens**

This condition may occur when it's cold. Wipe fogged CDs with a soft cloth. Fogged optical components inside the unit will return to normal operation after an hour in a heated environment.

**Optional Wireless Remote Control (Purchased Separately)**

To ensure maximum life of the optional wireless stereo remote, we recommend never submerging it in water or leaving it under the spa cover! Prolonged exposure to moisture will damage the remote!

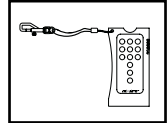

**Optional Wireless Remote Battery Replacement Procedure**

Remove remote from rubber housing, then remove protective adhesive seal from battery door. Depress hook with thumbnail and pull outward on battery door. Replace depleted battery with fresh battery, be sure to note polarity. Install battery door. Replace adhesive seal material, making sure to cover the entire cover gap (additional seal material included, if required). Replace remote firmly into rubber housing.

**Wireless Remote Control Specifications**

Usable range .....5m  
 Battery .....Coin Type, CR2025 or equivalent

**Optional Stereo Receiver Specifications**

**Tuner**

FM usable sensitivity .....10 dBf  
 FM 50 dB quieting sensitivity .....15 dBf  
 FM alternate channel selectivity .....90 dB  
 FM stereo separation @ 1kHz .....60 dBf  
 AM usable sensitivity .....30 uV

**CD Player**

Sampling frequency (8X oversampling) .....44.1 kHz  
 Channel separation @ 1 kHz .....80 db  
 Signal-to-noise ratio .....90 dBA  
 Frequency-to-noise response @ ±1 dB .....20-20 kHz

**Audio**

Maximum power output (45 watts x 4 channel) .....180 W  
 Continuous power, 20-20 kHz, 4 ohms, 1% THD .....18 x 4  
 Bass boost/cut .....10/100±dB/Hz  
 Treble boost/cut .....10/10+/-dB/kHz



General	
Nominal power supply	14.4 VDC
Allowable power supply	10.8-15.6 VDC
Current consumption	<10 Amp
Speaker impedance	4-8 Ohms

### 9.0 Automatic Filtration

Your spa is equipped with a small circulation pump which provides 24-hour water filtration and maintains the water temperature efficiently and economically. The circulation pump draws water through the stage 2 MicroClean™ filter cartridge (Section 11.1, Page 28). The only time the circulation pump will stop is if the actual water temperature exceeds the programmed set temperature by 1°C, a condition known as “summer logic.” When this occurs, the circulation pump remains off until the actual water temperature cools to the set temperature. Refer to the summer logic definition below for a thorough explanation of this feature.

***Summer Logic:*** *In warm weather, the water temperature in the hot tub may exceed the set temperature. This condition may occur due to heat transference from jets pump #1 and 24-hour circulation pump. If the water temperature is higher than 35°C and rises 1°C above the set temperature, a “Summer Logic” condition occurs that deactivates the circulation pump and ozonator (if equipped). ***This safety feature cannot be altered!*** The circulation pump and ozonator will remain off until the water temperature cools to the set temperature (except between 12AM-2AM when the circulation pumps runs for it’s mandatory 2-hour “clean-up” cycle when in summer logic). To help prevent a “Summer Logic” condition, it may be necessary to reduce the skimming/heating cycle run time in warm weather.*

### 9.1 Preset Skimming/Heating Cycle

Your hot tub comes with one one-hour skimming/heating cycle already programmed with a start time at 12:00 PM (noon). When the programmed start time is reached, jets pump 1 turns on to provide high-volume water filtration. You can easily change the start time, or the cycle length to suit your needs by following the steps outline in section 10.2 (Page 25).





### **9.2 Standard Skimming/Heating Mode**

In this mode, 2-stage water filtration is achieved by activating pump 1 for the programmed skimming/heating cycle. Water temperature is regulated by the set temperature, 24-hour circulation pump, and heater which turns on as needed. After the programmed set temperature is reached, the heater turns off and the circulation pump continues to operate 24-hours to filter and clean your spa through the MicroClean filter cartridge (unless programmed otherwise).

### **9.3 Economy Skimming/Heating Mode**

In this mode, the programmed skimming/heating cycle is disabled. Water temperature is regulated by the set temperature and 24-hour circulation pump. The circulation pump also filters and cleans the water by drawing it through the MicroClean filter cartridge.

### **9.4 Selecting Standard or Economy Skimming/Heating Mode**

Press the **MODE** button to select either “Standard” or “Economy” skimming/heating mode (Figure-E, Page 13). The control panel’s indicator on the right side of the LCD changes to indicate which mode is selected. When an automatic skimming/heating cycle activates, the LCD screen displays the following message:

**FILTER  
CYCLE                      ON**

### **9.5 Clean-Up Cycle**

The clean-up cycle is once per day in both Standard and Economy mode at 12:00 PM (noon) for two minutes. This is not user programmable. Pump #2 and blower activate for one minute to circulate any water in the plumbing. After 1 minute they both go off and Pump #1 runs for 1 minute. If the skimming/heating cycle is also set at 12:00 PM (noon), pump #1 will continue to run for the duration of the cycle.



## 10.0 Programming Instructions

### 10.1 Adjusting Time of Day

The Sentry control system remembers the time of day even in the event of a prolonged power outage. However, it may occasionally be necessary to reset the time of day. For example: if you are not in the Pacific Time Zone you will want to reset the time for your own time zone. (The system will automatically adjust to and from daylight savings time.) To accomplish this, press **DISPLAY, MODE** and **DISPLAY** within five seconds each. A number representing the hour will be displayed, followed by **AM** or **PM**. The hour will advance or decrease each time **UP** or **DOWN** is pressed within five seconds. Then, press **DISPLAY** again to display the minutes. Adjust the minutes as necessary by pressing **UP** or **DOWN**. After 5 seconds, the display will return to normal.

### 10.2 Changing The Skimming/Heating Cycle

The Sentry Control System allows you to easily adjust two separate aspects of the skimming/heating cycle (1) the time of day at which the cycle begins, (2) the duration of the cycle. To make adjustments, first press **CYCLE** to enter the skimming/heating cycle programming mode. The LCD screen will display the following in the upper right corner:

**ADJUST  
FILTER  
CYCLE**

**START TIME**

This means the system is ready to accept your changes to the start time for the skimming/heating cycle. Simultaneously, the large four-digit display in the center of the screen displays the currently programmed start time for the cycle. At this point, you have four options. You may:

- (1) Press **UP** or **DOWN** to adjust the start time in increments of 30 minutes.
- (2) Press **SELECT** to move down the menu from Start Time to Duration. Press **UP** or **DOWN** to adjust the duration in increments of 15 minutes.
- (3) Press **DISPLAY** to make the skimming/heating cycle programming characters disappear from the screen and the main display return to showing water temperature. If no sensor is pressed within 30 seconds, the screen automatically returns to the standard water temperature display.



At any time, you may check the programming of any aspect of the skimming/heating cycle by first pressing **CYCLE** then moving through the menu by pressing either **CYCLE** or **SELECT**. The programming is changed only by pressing **UP** or **DOWN** during this process.

### 10.3 Programming The Change Filter Reminder

Your new spa is equipped with a programmable “Change Filter” reminder that appears on the control panel display after a specified number of days. It is designed to remind you to clean and/or replace your filter cartridge(s) on a regular basis but does not affect spa operation in any way. This reminder must be reset at each filter cleaning interval. It offers a selectable range from 10-120 days or can be disabled. We recommend an initial setting of 30 days, after which you can easily determine whether you need to shorten or lengthen its interval by visually inspecting your filter cartridge. Refer to section 11.1 (page 28) for filter cleaning recommendations.



#### Programming Instructions

- (1) Press the **CYCLE** sensor three times. The main display reads “FIL” indicating the “Change Filter” display program has been accessed.
- (2) Press **SELECT** sensor once to display currently programmed duration or days elapsed since last filter cleaning interval.
- (3) Press **UP** or **DOWN** sensor to change duration as follows:  
0 - 10 - 20 - 30 - 40 - 50 - 60 - 70 - 80 - 90 - 100 - 110 - 120 - OFF
- (4) Press **DISPLAY** sensor once to save changes and return to the standard water temperature display. *Note: If no sensor is pressed within 30 seconds, the screen will automatically return to the standard water temperature display.*

### 10.4 Programming The Optional Ozonator Cycle

The Sentry control system allows you to easily adjust two separate aspects of the ozone cycle:

- The time of day (start time) the ozonator begins operating.
- The length of time (duration) the ozonator operates.

#### Programming Procedure:

- (1) Press the **CYCLE** sensor once. “Adjust 1” indicator displays.
- (2) Press **CYCLE** sensor a second time, “Adjust O<sub>3</sub>” indicator displays.



- (3) Press **SELECT** sensor, “Start time” indicator displays. Press **UP** or **DOWN** sensor to set ozone start time in 30 minute increments.
- (4) Press **SELECT** sensor, “Duration” indicator displays. Press **UP** or **DOWN** sensor to set ozone duration in 2 hour increments.
- (5) Press **DISPLAY** sensor to exit setup and return to normal water temperature display.

### 10.5 Locking The Skimming/Heating Cycle

You may keep the skimming/heating cycle program from being inadvertently altered by electronically “locking” it. To accomplish this, simply press **CYCLE** then, within 30 seconds, press **DISPLAY, MODE** and **UP**, within five seconds each. A padlock symbol will appear on the screen. In this state, the status of the cycle programming may be checked, but may not be altered. To unlock the cycle programming to make changes, simply press **DISPLAY, MODE** and **DOWN** within five seconds each.

### 10.6 Panel Lock

To help prevent unauthorized use of your hot tub, the Sentry controls incorporate a unique panel locking system which disables the controls on the panel.

**To Lock The Panel:** Press the **DISPLAY, MODE**, and **UP** sensor pads, in order, within five seconds. A padlock symbol will appear on the LCD screen. With the panel locked, none of the components can be turned on and the only settings that can be adjusted are the standard/economy operating mode and changing the time of day. All automatic hot tub functions will operate normally.



**To Unlock The Panel:** Press **DISPLAY, MODE**, and **DOWN**, in order, within five seconds. The “lock” symbol will disappear. All sensor pads are now active.



### 10.7 Temperature Setting Lock

To electronically lock the temperature setting, first enter the “temperature setting” mode by pressing **UP** or **DOWN**. Then, within five seconds, press the three sensors described under “To Lock The Panel” above. This will prevent the temperature setting from being changed by unauthorized persons but all other sensors will remain active. To unlock the temperature setting so that it can be adjusted, simply follow the instructions above under “**To Unlock The Panel**” above.



## 11.0 Hot Tub Maintenance

Proper and regular maintenance of your hot tub will help it retain its beauty and performance. Your authorized Sundance Dealer can supply you with all the information, supplies, and accessory products you will need to accomplish this.

### 11.1 Cleaning The Filter

A programmable “Change Filter” reminder flashes on the control panel display after a specified number days to remind you to clean (or replace) your filter cartridge(s). This reminder must be reset at each cleaning interval. Refer to section 10.3 (page 26) for additional information and programming details.



Your Sundance hot tub is equipped with an exclusive MicroClean™ 2-stage filter located under the filter lid (Figure-F, Page 14). Larger debris is filtered by pump #1 drawing water through the larger (stage 1) cartridge during normal operation and at each skimming/heating cycle. Fine debris is filtered by the circulation pump drawing water through the smaller (stage 2) cartridge. Both halves work together to give you unsurpassed water quality! To ensure optimum performance, clean and reuse the stage 1 cartridge once a month and replace the stage 2 cartridge every 3 months.

All models include filters on their footwell suction covers (Page 14) that prevent debris from entering pump 2 and the diverter valve(s), when operating. These filters must remain in place to protect these components from debris entrapment/damage. They should be cleaned every 2 months, or when weak pump 2 performance is observed.

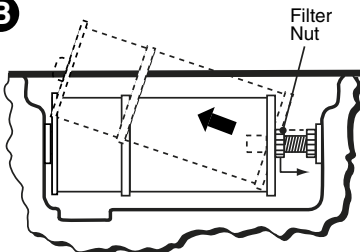

***ALWAYS TURN POWER TO THE HOT TUB OFF BEFORE CLEANING THE FILTER CARTRIDGE!*** To accomplish this, refer to the filter cleaning/replace-ment procedure below:

**A****TURN POWER TO HOT TUB OFF!****B**

Loosen filter nut to provide clearance, then remove filter assembly.

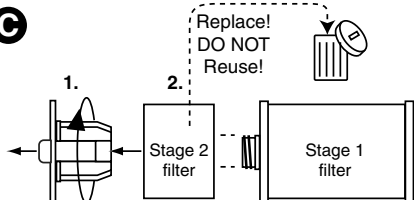
**C**

1. Rotate stage 2 retainer **counterclockwise** to release, then separate filter assembly.
2. Replace (throw-out) the stage 2 filter after 3 months use or as needed. **DO NOT REUSE!**

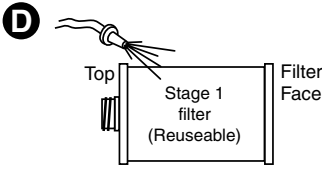

Rinse debris from the stage 1 filter pleats using a garden hose and high-pressure nozzle. Start at the top and work downward to the face. Repeat process until all filter pleats are clean.

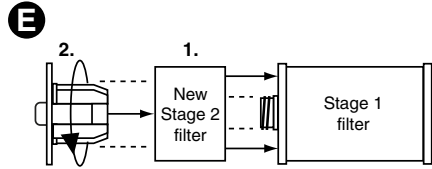

1. Install new stage 2 filter onto clean stage 1 filter.
2. Insert retainer into stage 2 filter and rotate **clockwise** to assembly. **DO NOT** overtighten retainer (finger tight only).

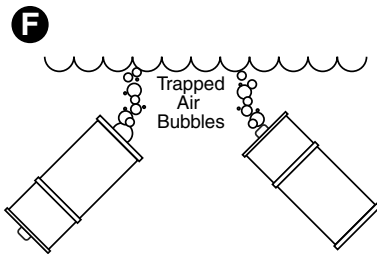

Submerge assembled filter in spa and tilt each end upward to remove trapped air bubbles from inside each filter cavity.

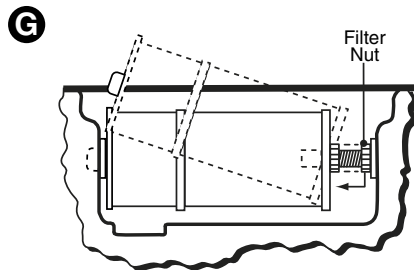

1. Install filter assembly, then tighten filter nut so it just touches filter face. **DO NOT OVERTIGHTEN!**
2. Turn power to hot tub back on.

Periodically, the stage 1 filter will need a more thorough cleaning to remove imbedded oils and minerals. For this, we suggest cleaning as illustrated above (step D), followed by soaking the filter overnight in a plastic container filled with a solution of water and a specially formulated filter cleanser available from your Sundance dealer.

The average life expectancy of the stage 1 filter is approximately two years with proper care and water quality maintenance. **The smaller stage 2 filter cannot be cleaned and must be replaced (thrown-out) every 3-months, or as needed.** Attempts to reuse this cartridge will reintroduce debris into your hot tub! Replacement cartridges may be purchased from your Sundance dealer.

**Note:** Nylon suction filters need to be cleaned periodically for optimum performance of all jets (See Figure-F, Page 14).

## 11.2 Draining and Refilling

About every 3 to 6 months, you will want to replace the hot tub's water. The frequency depends on a number of variables including the amount of



use, attention paid to water quality maintenance, etc. You will know it is time for a change when you cannot control sudsing and/or you can no longer get the normal feel or sparkle to the water even though the key water balance measurements are all within the proper parameters.

**CAUTION! READ THIS BEFORE DRAINING:** *To prevent damage to the hot tub's components, **turn off power to the hot tub at the circuit breaker before draining it.** Do not turn the power back on until your hot tub has been refilled. There are certain precautions to keep in mind when draining your hot tub. If it is extremely cold, and the hot tub is outdoors, freezing could occur in the lines or the equipment (see "WINTERIZING", Page 32). On the other hand, if it is hot outdoors, do not leave the hot tub's surface exposed to direct sunlight for long periods.*

### **Draining Procedures:**

For Hot Tubs with An External Drain Valve

1. Turn off power to hot tub at breaker.
2. Locate the 3" gray drain valve cap on the left or right side of the hot tub. Unscrew drain valve cap to expose the underlying male garden hose fitting. Attach hose to fitting and route opposite end away from hot tub.
3. Pull outward on garden hose at drain connection (approx. 3/8") to open valve and release water. Water drains at approximately 3 gallons per minute.
4. Close drain valve by pushing inward on garden hose at drain connection until you feel it bottom out, then remove garden hose, install gray drain cap, and refill spa. Refer to "Start-Up Instructions" (page 9).

### **11.3 Cleaning The Hot Tub Interior**

To preserve the sheen of your hot tub's surface, it is crucial that you avoid using abrasive cleaners or cleaners which have adverse chemical effect on the surface. If you are not certain as to the suitability of a particular cleanser, consult your authorized Sundance Dealer.

Regardless of the cleanser used, use extreme care to assure that no soap residue is left on the surface. This could cause severe sudsing when the hot tub is refilled. Your Sundance Dealer offers a specially formulated surface sealant which aids in cleaning the hot tub surface and adds a protective coating to enhance the luster of the surface. This product should also be occasionally applied to the stainless steel grab rails and accents in the hot tub to help preserve their appearance.



### 11.4 Pillow Care

Remove and clean the headrest pillows as needed with soapy water using a cloth or soft-bristle brush. To maintain water resistance and luster, apply a quality vinyl conditioner once a month. Always remove the pillows when adding chemical shock treatment to the hot tub water. The pillows can be returned to the hot tub when the sanitizer reading drops below 5 ppm.

**IMPORTANT:** Never attempt to remove the pillows by pulling on them! The pillows utilize a bolt-on design that prohibits removal without tools.

To remove pillows:

1. Grasp center pillow insert (A) with finger tips and gently pry outward from pillow base (C).
2. Use a standard screwdriver to loosen and remove mounting bolts (B) from pillow base.
3. Assemble in reverse order after cleaning.

**DO NOT overtighten pillow mounting bolts!**

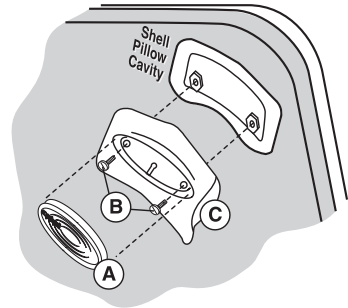

### 11.5 Maintaining The Wood Cabinet

With time and exposure to the elements, the wood on your hot tub will tend to lose its new appearance. Protecting or reviving the wood surfaces is a fairly simple process. Light sanding with fine-grit sandpaper will help smooth any roughness and regular applications of a penetrating wood preservative will enhance and protect the richness of the wood. A specially formulated wood stain available from your Sundance dealer is ideal for this.

**NOTE:** *Do not apply varnish, shellac or other surface sealants to the wood. These tend to react with the chemicals in the wood and the UV rays of the sun, causing yellowing, flaking and peeling.*

### 11.6 Maintaining The Optional Synthetic Cabinet

The optional synthetic cabinet requires little or no maintenance of any kind. To clean, simply wipe cabinet with a clean towel and mild detergent soap solution.

**CAUTION:** Never spray cabinet with a garden hose for any reason since this action may induce an electrical short in the spa's electrical equipment.





### 11.7 Maintaining The Cover

Using the Sundance insulating hot tub cover anytime the hot tub is not in use will significantly reduce your operating costs, heat-up time and maintenance requirements. To prolong the life of the cover, handle it with care and clean it regularly using mild soap and water. Periodic treatments with a special conditioner developed for Sundance hot tub covers will help protect against deterioration caused by U.V. rays from the sun. Never allow anyone to stand or sit on the cover, and avoid dragging it across rough surfaces.

### 11.8 Winterizing

Your Sundance hot tub is designed to automatically protect itself against freezing when operating properly. During periods of severe freezing temperatures, you should check periodically to be certain that the electrical supply to the hot tub has not been interrupted. In extreme, bitter cold weather (less than  $-29^{\circ}\text{C}$ ) reset the skimming/heating cycle for 24-hour operation to protect the hot tub. If you do not intend to use your hot tub, or if there is a prolonged power outage during periods of severe freezing temperatures, it is important that all water be removed from the hot tub and equipment to protect against damage from freezing.

**For expert winterization of your hot tub, contact your authorized Sundance Dealer.** In emergency situations, damage can be minimized by taking the following steps:

**CAUTION: Turn off power to hot tub.**

1. Follow the directions on page 30 for draining the hot tub.
2. As the water level drops below the seats, use whatever means necessary to get the water out of the recessed seating areas and into the footwell.
3. When the water level ceases to drop, use whatever means available to remove any remaining water from the footwell.
4. Turn the power to the hot tub back on briefly and press the **AIR** button to activate the air blower. This will evacuate the water from the air injector lines. (Note: Stand back to avoid the misty spray.)
5. *Turn off power to the hot tub.*
6. Remove the equipment-side cabinet panels and locate the drain plugs in the front of the pump(s) (Figure-A, Page 6). Remove these plugs to allow the water to drain out of the pumps and heater. (Note: Approximately one to two gallons will be released during this procedure. Use a wet/dry vacuum or other means to keep this from flooding)



the equipment compartment. Replace the drain plugs.

7. Loosen hose clamp at bottom of heater (Figure-A, Page 6) and pull hose off of heater fitting (twist the hose back and forth while pulling downward). Tip hose down and allow to drain.
8. Re-install cabinet side panels and cover hot tub so that no casual moisture can enter into it. Consult your Authorized Sundance Dealer if you have any questions regarding winter use or winterizing.

### **11.9 Restarting Your Hot Tub in Cold Weather**

If you want to start up your hot tub after it has sat empty for a time in freezing temperatures, be aware that the water remaining in certain sections of the piping may still be frozen. This situation will block water flow preventing the hot tub from operating properly and possibly damaging the equipment. We recommend you consult your dealer for guidance before attempting to re-start your hot tub under these conditions.

### **11.10 Handrail Maintenance**

The handrails in your Sundance spa are manufactured from a high quality 316 stainless steel alloy. Many people are familiar with the term “stainless steel” and are surprised to learn that it does indeed rust and corrode in the presence of chloride salts, free chlorine, or sulfide gasses. The bad news is the environments that produce these elements are ocean spray, salted highways, chemical treatments added to swimming pools and spas, and ground water in numerous coastal areas. The good news is with proper care, your spa’s handrails can maintain their original finish.

#### **If your stainless handrails shows signs of rusting you should:**

- Wash with fresh water (a good detergent won’t hurt).
- Clean with a good car chrome polish.
- Wax with an automotive or fiberglass wax.

#### **You should never:**

- Clean with chlorinated cleaners or scouring powders.
- Use sand paper, “Scotch Brite”, Brillo pads, or similar abrasive products.
- Clean with muratic or hydrochloric acids. Vinegar is ok, but it won’t do much to remove rust.

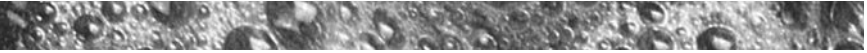

## 12.0 Water Quality Maintenance

Maintaining the quality of the water within specified limits will serve to enhance your enjoyment and prolong the life of the hot tub's equipment. It is a fairly simple task, but it requires regular attention because the water chemistry involved is a balance of several factors. There is no simple formula, and there is no avoiding it. A careless attitude in regard to water maintenance will result in poor and potentially unhealthful conditions for soaking and even damage to your hot tub investment. For specific guidance on maintaining water quality, consult your Authorized Sundance Dealer who can recommend appropriate chemical products for sanitizing and maintaining your hot tub.

**CAUTION:** *Never store hot tub chemicals inside the hot tub's equipment bay.*

### 12.1 pH Control

pH is a measure of relative acidity or alkalinity of water and is measured on a scale of 0 to 14. The midpoint of 7 is said to be neutral, above which is alkaline and below which is acidic. In hot tub water, IT IS VERY IMPORTANT TO MAINTAIN A SLIGHTLY ALKALINE CONDITION OF 7.2 to 7.8. Problems become proportionately severe the further outside of this range the water gets. A low pH will be corrosive to metals in the hot tub equipment. A high pH will cause minerals to deposit on the interior surface (scaling). In addition, the ability of the sanitation agents to keep the hot tub clean is severely affected as the pH moves beyond the ideal range. That is why almost all hot tub water test kits contain a measure for pH as well as sanitizer.

### 12.2 Sanitizing

To destroy bacteria and organic compounds in the hot tub water, a sanitizer must be used regularly. Your Sundance hot tub is equipped with the Brominator™, a special compartment built into the floating skimmer gate to hold bromine tablets. By regulating the number of bromine tablets in the Brominator™ and the length of the filtration cycles, you can control the amount of bromine which is actively working in your hot tub water. A bromine residual of 2 to 3 ppm is generally considered desirable. A two-part bromine system or granular chlorine (Dichlor) are also acceptable sanitizers.

**IMPORTANT:** *Do not use chlorine tablets (Trichlor) in your hot tub. This chemical can have an extremely corrosive effect on certain materials in the hot tub. Damage caused by use of this chemical, or improper use of any chemicals, is not covered under the hot tub's warranty.*



### 12.3 Other Additives

Many other additives are available for your hot tub. Some are necessary to compensate for out-of-balance water, some aid in cosmetic water treatment and others simply alter the feel or smell of the water. Your Authorized Sundance Dealer can advise you on the use of these additives.

### 12.4 Optional SunZone™ Water Maintenance System

If you have elected to have your hot tub equipped with the optional Sundance SunZone™ UV or SunZone™ CD water purification system you will find that your water stays fresh and clear with significantly less chemical sanitizer usage. You will also probably be able to go longer between complete hot tub drainings.

## 13.0 Troubleshooting - Display Messages

There are a number of unique functions designed into your Sundance hot tub to protect it from damage and/or to aid in troubleshooting. Following is a listing of all the possible messages along with their meanings:

#### MESSAGE

#### MEANING

**OH**

Overheat Protection (Heater is deactivated, pump’s low speed is activated). Water temperature is above acceptable limits. Do not enter the water! Remove hot tub cover to speed cooling. See “WATER IS TOO HOT” on page 38. If condition persists, contact your dealer or authorized service center.

**COOL**

If the hot tub water is more than 8°C cooler than the temperature setpoint, pump #1 and heater will automatically activate to provide freeze protection. The hot tub will stay in this mode until the water temperature reaches 8°C below the set temperature. No corrective action is necessary.

**FLO\***

FLOW SWITCH (Heater is deactivated. Pump may also be deactivated). Proper flow of water is inhibited or a flow switch has malfunctioned. Check for proper water level and check for clogged stage 2 filter (Page 28-29). Contact your dealer or service organization.

**\*NOTE: THIS MESSAGE CAN ALSO APPEAR IF THE PUMP HAS NOT REGAINED PRIME AFTER THE HOT TUB HAS BEEN DRAINED AND**



**REFILLED. IF YOU SUSPECT THAT THIS IS THE CASE, SEE THE INSTRUCTIONS ON PAGE 37 UNDER "PUMP DOES NOT OPERATE..."**

**Hold**

Panel sensors have been pressed too many times in a short period of time. Because this could cause excessive wear on equipment components, panel sensors are temporarily deactivated. Panel sensors will automatically re-activate if no sensor is pressed for 30 seconds.

**HOT**

Circuit board temperature has exceeded acceptable limit. This message will disappear when the circuit board temperature drops below acceptable limit. If condition persists, provide shade for the equipment side of the hot tub.

**ICE  
ICE2**

**FREEZE PROTECTION**

A potential freeze condition has been detected. No action is required. Pump(s) operate until the hot tub is out of danger.  
*Note: This error commonly occurs when the hot tub is first filled because tap water is often very cold.*

**PnL**

Communication between the control panel and/or remote control panel and circuit board is faulty. Contact your dealer or service organization.

**----**

"WATCHDOG" (Hot tub is deactivated). A problem has been detected which could cause damage to the hot tub or its components. Contact your dealer or service organization.

**Sn1**

OPEN SENSOR (heater disabled) OR SHORTED SENSOR (hot tub is deactivated). The high-limit temperature sensor is non-functional. This must be repaired only by a dealer or qualified service organization.

**Sn3**

OPEN OR SHORTED SENSOR (heater disabled). The main sensor is non-functional. This must be repaired only by a dealer or qualified service organization.

**FL02**

CLOSED OR SHORTED FLOW SWITCH ON SYSTEM STARTUP (system disabled). Flow switch is non-functional. This must be repaired only by a dealer or qualified service organization.



## 14.0 Troubleshooting - Procedures

In the unlikely event your hot tub is not working the way you believe it should, please first review all installation and operating instructions in this manual and check the message on the panel display; second, if you are still not satisfied it is working properly, please follow the appropriate troubleshooting instructions.

### PROBLEM

NONE OF THE COMPONENTS OPERATE (i.e. pump, blower, light)

### PROCEDURE

Check the control panel lights.

1. If there are letters or symbols displayed on the screen, refer to the previous section to determine meaning and action required.
2. If nothing appears on the screen:
  - a. Check the household circuit breaker.
  - b. Contact you dealer or authorized service center.

PUMP DOES NOT OPERATE BUT BLOWER AND LIGHT DO OPERATE

Depress "JETS" sensor.

1. If no sound is detected or if a "buzzing" sound is detected, turn off power to the hot tub and contact your dealer or service center.
2. If motor operates but no water flows to jets:
  - a. Pump may not be properly primed. See instructions below.
  - b. Contact dealer or authorized service center.

### **Pump Priming Instructions: *Turn Hot Tub Off!***

Remove filter and insert end of garden hose into left-side filter fitting. Seal-off fitting opening around hose using a large, clean rag and hold in place. Ask a helper to turn on maximum water flow through the garden hose. After about 30 seconds, turn off water. Repeat process for right-side filter fitting, then remove hose and rag. Reinstall filter as illustrated in section 11.1 (page 28-29) and activate pump 1. Another method of priming the hot tub's pump(s) is as follows:

1. Turn off the power to the hot tub.
2. Remove the handle from the massage selector supplied by the pump you are priming.
3. Loosen the massage selector's cap slightly (counterclockwise), listening for the air to seep out.
4. Tighten the cap finger-tight, replace the handle and turn the hot tub's power back on.



(Note: This method must be used for pump #2 of all Altamar, Cameo, Marin, and Optima models because pump #2 is not connected to the filter.)

**IMPORTANT:** *If freezing conditions exist and pump is not operational, take measures to protect the system from freeze damage. See "Winterizing" (page 32).*

**POOR JET ACTION**  
*(Figure-F, Page 14)*

1. Make certain the pump is on.
2. Check position of massage selectors
3. Open air control for selected jet system.
4. Check for adequate water level.
5. Check for dirty filter (Page 28-29).
6. Check for dirty filters on all three pump 2 footwell suction covers (Page 14).

**WATER IS TOO HOT.**

1. Reduce thermostat setting (Page 11).
2. Reduce filtration cycle length. Even with heater off, water temperature can increase from prolonged pump operation (Page 25).

**NO HEAT**

1. Check thermostat setting.
2. Keep the cover in place while heating.
3. If "heater on" indicator is lit (*Figure-E, Page 13*), but no temperature rise is experienced after a reasonable period of time, contact your dealer or authorized service center.

Should checking the above steps fail to correct the problem, please call your dealer so that he may arrange service.

Sundance builds the best hot tubs in the industry. Nonetheless, we are always striving to improve the quality and features of our products. Your input as a Sundance hot tub owner is a cherished part of this process. If you have any comments or suggestions, or if you wish to be informed on any new products for your hot tub, please write to us.

CONGRATULATIONS on your good taste and welcome to the happiest and most relaxed family in the world!



# 15.0 Jumper Configurations / Max Current Chart

Circuit Board Jumpers (See Diagram, Page 40)						Total Current Draw						
JP9-5	JP9-7	JP9-9	JP9-11	Circ. Pump	Pump 1	Pump 2	Blower	Light	Power Supply 1	With Heater	Power Supply 1+2	Factory Setting
0	0	0	0	ON	ON		ON	ON	12.1 Amp (2.9kW)	X	23.6 Amp (5.6kW)	
0	0	0	1	ON	ON		ON	ON	12.1 Amp (2.9kW)		12.1 Amp (2.9kW)	
0	0	1	0	ON	ON		ON	ON	12.1 Amp (2.9kW)	X	23.6 Amp (5.6kW)	
0	0	1	1	ON	ON	ON		ON	16.6 Amp (3.9kW)		16.6 Amp (3.9kW)	A
0	1	0	0	ON	ON		ON	ON	12.1 Amp (2.9kW)	X	23.6 Amp (5.6kW)	B
0	1	0	1	ON	ON		ON	ON	12.1 Amp (2.9kW)		12.1 Amp (2.9kW)	
0	1	1	0	ON	ON		ON	ON	12.1 Amp (2.9kW)	X	23.6 Amp (5.6kW)	
0	1	1	1	ON	ON	ON		ON	20.1 Amp* (4.8kW)		20.1 Amp (4.8kW)	*
1	0	0	0	ON	ON		ON	ON	12.1 Amp (2.9kW)	X	23.6 Amp (5.6kW)	
1	0	0	1	ON	ON		ON	ON	12.1 Amp (2.9kW)		12.1 Amp (2.9kW)	
1	0	1	0	ON	ON		ON	ON	16.6 Amp (3.9kW)	X	28.1 Amp (6.7kW)	
1	0	1	1	ON	ON	ON		ON	16.6 Amp (3.9kW)		16.6 Amp (3.9kW)	
1	1	0	0	ON	ON		ON	ON	12.1 Amp (2.9kW)	X	23.6 Amp (5.6kW)	
1	1	0	1	ON	ON		ON	ON	12.1 Amp (2.9kW)		12.1 Amp (2.9kW)	
1	1	1	0	ON	ON	ON		ON	20.1 Amp* (4.8kW)	X	31.6 Amp (7.6kW)	*
1	1	1	1	ON	ON	ON		ON	20.1 Amp* (4.8kW)		20.1 Amp (4.8kW)	*

### Chart Symbol Legend

- 0 = Jumper Off
- 1 = Jumper On
- ON = Device On
- Pump 1 = 8 Amp,
- Pump 2 = 8 Amps
- Circulation Pump = 0.5 Amps,
- Blower = 3.5 Amps
- Light = 0.1 Amps

\* The system fuse and fuse holder (F1) on these models must be changed to 25 Amps to accommodate the higher current draw from these models.

A = Factory Setting for Cameo, Optima, Marlin and Altamar  
 B = Factory Setting for Capri



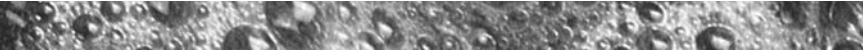

# 16.0 Electrical Wiring Diagram Export 50Hz

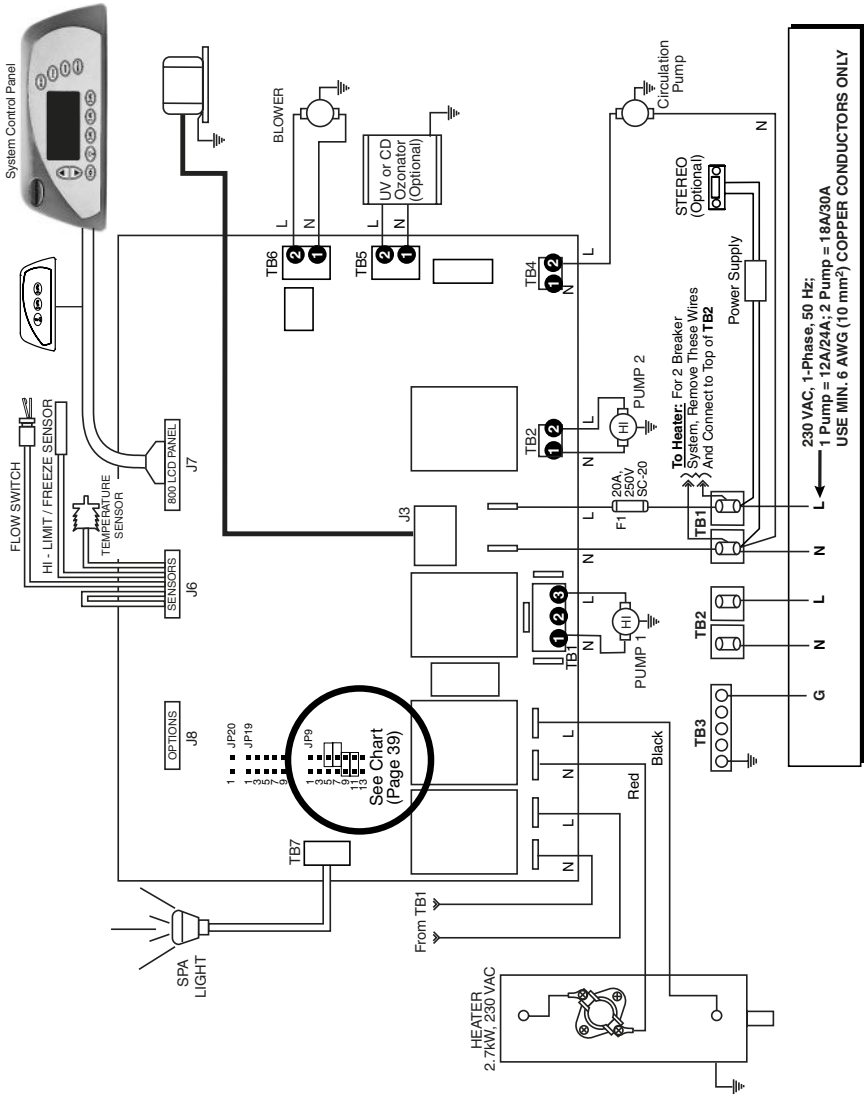

## **Sundance Spas, Inc.**

14525 Monte Vista Ave, Chino, CA 91710/U.S.A.,

Phone: (909) 606-7733, Fax: (909) 606-0195

Website: <http://www.sundancespas.com>